

# Advanced Energy Metering System Using IOT

Santosh K Tripathi<sup>1</sup>, Swati Maurya<sup>2</sup>, Ajeet Kumar<sup>3</sup>, Koshtubh S Raj<sup>4</sup>, and Rajneesh Rawat<sup>5</sup>

<sup>1,2</sup> Assistant Professor, Department of Electrical Engineering, Rajkiya Engineering College, Kannauj, India

<sup>3,4,5</sup> B.Tech Scholar, Department of Electrical Engineering, Rajkiya Engineering College, Kannauj, India

Correspondence should be addressed to Santosh K Tripathi ; [santosh@reck.ac.in](mailto:santosh@reck.ac.in)

Received: 2 May 2024

Revised: 16 May 2024

Accepted: 30 May 2024

Copyright © 2024 Made Santosh K Tripathi et al. This is an open-access article distributed under the Creative Commons Attribution License, which permits unrestricted use, distribution, and reproduction in any medium, provided the original work is properly cited.

**ABSTRACT-** In recent times, there has been a swift advancement in the creation of smart cities. A smart city is a metropolitan area that makes use of cutting-edge technology for effective resource management and monitoring. The goal is to maximize energy and cost savings while simultaneously enhancing the quality of life for its citizens. With an emphasis on energy-related monitoring, a smart energy meter is the fundamental element that forms the basis for all data gathering, analysis, and automation. This paper describes how to turn a regular energy meter into a smart energy meter by adding an Arduino and a GSM module. With the help of the Internet of Things, this smart energy meter is further improved using IoT. An embedded controller (Arduino) and a GSM modem will be integrated by the smart energy meter system to transfer data over a GSM mobile network, such as generated invoices, spent energy in kWh, etc. IoT can be used to enable energy providers and power companies to monitor and control their customers' services without the need for human labour by providing them with the user-generated data. By connecting the smart meter to the Internet of Things, the user can access the data using a password and ID that has been issued from any location in the globe. Major energy companies will benefit from our project's user-friendliness, reduced labour costs, and decreased error and loss rates.

**KEYWORDS-** Arduino (Microcontroller), Global System for Mobile (GSM), Internet-of-Things (IoT), Smart Energy Meter (SEM), Short Message Service (SMS), Wireless Fidelity (Wi-Fi).

## I. INTRODUCTION

Urbanization, like in emerging nations, causes technology, gadgets, and appliances to increase more quickly. At the same time, population growth is high, which raises the need for energy. Because of the necessity for quick economic development and growth in emerging countries, as well as the sharp rise in industrial and commercial activity, energy demand is rising [3]. Therefore, the power production, transmission, and distribution systems will face significant challenges if we continue to employ the conventional energy management method. A diverse strategy is needed to address these issues, one that includes developing technology that can meet energy demands while reducing their negative effects on the environment, adopting renewable energy sources, and implementing energy efficiency measures. The energy distribution firms will be able to handle billing system and energy consumption data more quickly and easily with the aid of this article, which will expedite their

operations and increase accuracy [10].

The digital energy meters that are now used in our electrical system are manually read, billed, and monitored. Furthermore, the procedure of monitoring and charging takes a great deal of time and work. The purpose of this study is to design a smart energy meter that is capable of monitoring, recording, and billing using the Internet of Things (IoT). Here, the Internet of Things serves as the project's central component and is essential to converting a conventional energy meter into an intelligent and effective energy metering system. It allowed for the remote reading and observation of the data. This change not only improves the functionality and efficiency of utilities, but it also provides the distribution firm with the capacity to easily and intelligently monitor and operate the energy management system. Additionally, it gives customers the means to use the Internet to access, track, and manage their data. IOT is able to enable this smart meter realize its capabilities. This will enable the businesses to continuously monitor the data on energy consumption. Through IOT, the solution assists the user in tracking real-time energy consumption on their smartphone [4]. To benefit society, this project will combine the greatest features of both IoT and GSM technologies. The primary benefits offered by this system include:

- Real-time monitoring
- Automated invoicing
- Data control and remote access, etc.

The management, reading, and billing of energy data will undergo a revolution thanks to this technology, which will eliminate manual work and save money and time by automating tasks that would otherwise require human labor. It reduces the possibility of human mistake, processing lag, and electricity theft, allowing you to obtain precise readings and reasonable electricity costs.

As of May 21, only 1.7 million households nationwide have smart energy metering services, according to the Smart Meter National Program (SMNP), which is overseen by the government of India-owned Energy Efficiency Services Limited (EESL). The Government of India aimed to install 250 million smart meters in all states over the next three to four years, based on the results of this survey, which makes this paper much more relevant and important [3].

## II. SYSTEM DESCRIPTION

Based on recent efforts and advances, a single-phase, low-cost domestic SEM system that tracks energy utilization has been developed. The system consists of a smart energy meter

(sensing device) and wireless media. For the purpose of communicating with the entire system, the sensing device is connected to the wireless medium. The data from the energy meter is collected and transmitted wirelessly from a microcontroller (such an Arduino, Raspberry Pi, etc.) [11].

**A. Methodology**

An Arduino microcontroller is typically connected to a conventional energy meter. Every calculation that needs to be done on the demand side and subsequently relayed to the server side is handled by the Arduino. GSM modules are the most common type of communication equipment used for data transport [1,2]. At the conclusion of each cycle, an automated bill is generated by the server-side, which then effectively stores data and updates on the web itself. In order to achieve remote control over the different parameters that can be changed for effective power management, there is also a server-to-client communication mechanism involved [12]. Consequently, this bidirectional communication line guarantees both automation and optimization, serving as the cornerstone around which the entire process of power management is built. The conventional energy meter in the proposed model has an external circuit connected to it that first connects to an LCD display to show the energy consumption's current value or reading. The system's core component is the Arduino. It computes the units and associated cost for the opto-coupler's continuous pulse monitoring and then transmits the result to the GSM module and LCD display that are linked to the Arduino [6]. The cloud infrastructure and IoT hardware architecture revolve around the GSM module. It notifies the user of the data obtained from the Arduino through SMS, or the values can be viewed on different web-apps [4].

**B. Block Diagram**

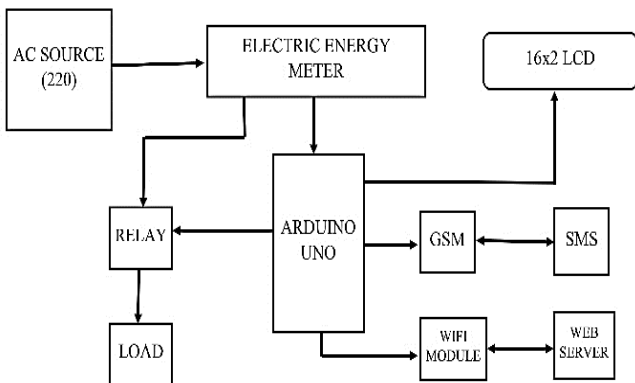

Figure 1: Block diagram for SEM

The functioning of a smart energy meter system depends on a number of components and technology. The brains of the system are Arduino in the suggested design. He, an LCD display, a GSM/WI-FI module, a relay, and an energy meter are all linked to an Arduino. The main line connects the energy meter to the AC source, while the load line connects it to the load. Additionally, there is a relay that the Arduino itself controls that is placed between the meter and the load. When necessary, the relay is used to divert the load from the supply [1,4,11].

The Arduino is linked to the energy meter, and it sends pulses to the Arduino as input signals using Optocoupler. Codes are encoded in the Arduino to enable it to function as

intended. It converts the pulses into data and shows it on the attached LCD. The units used by the user and their associated costs make up the proposed data [12-15].

This GSM/Wi-Fi module can communicate with the Arduino in both directions. While the module communicates with the cloud infrastructure and the circuit, Arduino starts it. This module's primary job is to receive the computed unit values and transmit them via any wireless channel. The module is connected to a device, like web servers or mobile devices, over this wireless means.

Here, the Arduino is connected to two separate modules: the GSM module and the Wi-Fi module. While the WIFI module connects the web server through IOT, the GSM module uses SMS services to connect the mobile device [13,14].

**C. Development using IoT**

The Internet of Things is referred to as IOT. An essential component of Internet of Things-enabled smart meters is the node MCU module [4,5]. It is a network of connected gadgets that can share information and enable internet-based communication amongst the various devices. Any kind of equipment can be used, including household appliances, automobiles, industrial machinery, electronic gadgets, and any machine or sensor that is connected to a network. The primary goal of the Internet of Things is to link devices to one another over a network and utilize those devices to gather and distribute data, which enhances productivity, performance, automation, and the system's ability to make decisions [7].

Systems may now remotely operate and transfer data to various areas of connected devices via a network thanks to the Internet of Things. The Arduino is connected to the various parts, and it uses the meter's readings of current, voltage, and power consumption to send the information to the LCD and communication module. The communication module transmits the data to the server, and the LCD shows the data (power consumed). The primary control of the smart meter is determined by the central system, which is utilized to retrieve data from the server. Additionally, it gives the customer a ID and Password to view the data online from a distance. Smart meters are equipped with various security methods such as authentication and encryption to ensure the confidentiality and integrity of data transferred [8,9]. This is required to prevent tampering and unauthorized access.

**III. MATHEMATICAL ANALYSIS**

In Conventional Energy Meter, it takes 1500 to 3000 blinks of Cal LED of meter to consume 1 unit of power.

But for practical implementation in limited time, we have taken i.e.

10 blinks = 1 unit.

Now to calculate Consumption cost, we let

X be the number of LED blinks.

Y is the quantity of power in units.

Z is the consumption cost.

Then,  $Y = (X/10)$

Let us assume a unit cost of 10 Rupees. Then,

$Z = Y * 10rs$

For example-

when 30 blinks are read by Arduino, it will calculate

Unit consumed( $Y$ ) =  $X/10 = 30/10 = 3$

Now the cost of consumption( $Z$ ) =  $3*10Rs = 30Rs$

Here we also set the threshold value of meter to 5 units on



reaching it, Buzzer in the circuit will beep to indicate recharge is needed for functioning of meter.

#### IV. RESULTS AND DISCUSSION

The results of the model discussed are shown here:

##### A. Design of Proposed Model

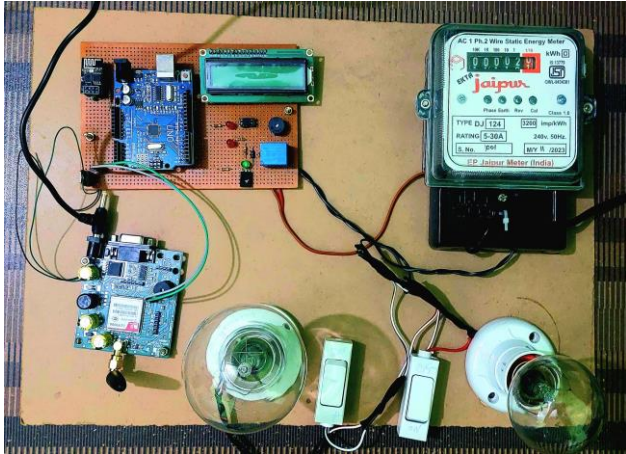

Figure 2: Proposed Model

The presented model in Fig 2 has a conventional energy meter, Arduino as controller, LCD display, an optocoupler and a relay. The model also has two modules namely GSM module and Node MCU. It also has some loads connected to it, for reference which taken as bulbs with different wattages. The main AC supply is given to the electric meter. The cal sign of meter is connected to optocoupler which calibrates it according to the command of Arduino. Arduino is also connected to the LCD which displays the data of amount of recharge and units consumed. Relay is also provided to protect the circuit from overcurrent. Loads are connected to the meter through the relay. Arduino uses GSM and Node MCU to transfer the data wirelessly to the SMS and webservice respectively.

##### B. Working of Model



Figure 3: When only one load is connected to supply

The proposed model works with the integration with three main fields of engineering i.e. Electrical, Electronics and Computer Science. The units consumed by the user is calculated using a conventional energy meter which is

connected to Arduino. Arduino collects the data and display it on the LCD while also transferring the data wirelessly to the phones via SMS and Webservers. In Fig 3 and 4 we have used the model in two modes. In Fig 3 only one load is connected to supply while in Fig 4 two parallel loads are connected to supply.



Figure 4: Loads are connected to supply

##### C. Data received via SMS

Here the data is received on the consumer Mobile Phone using SMS services. SMS service also provide a chain a command so as to recharge the energy meter and demand the data at any time and also other feature.



Figure 5: Data received via GSM Module

In Fig 5, the SMS services of the model is shown. Here whenever the meter is ON it will send the 'Welcome To Energy Meter' SMS to the user. The user can use the 'Data' command to access price and unit consumed from the meter.

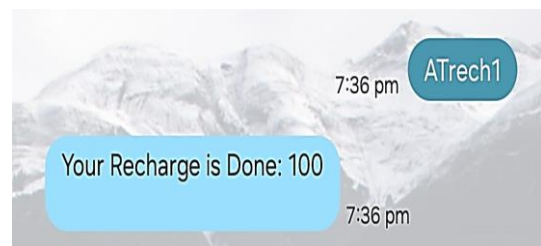

Figure 6: Easy recharging option via SMS

In Fig 6, the use of ‘ATrech’ command is depicted. The GSM module SIM900a configurable via AT command. Here we have used the AT command to recharge the Energy Meter.

In Fig 7, warning from the meter is received. There are two types of warnings i.e. about low balance in the meter and when the balance is finished.

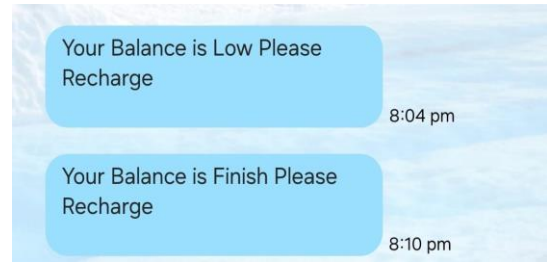

Figure 7: Notification when balance is low

**D. Readings on Web Server**

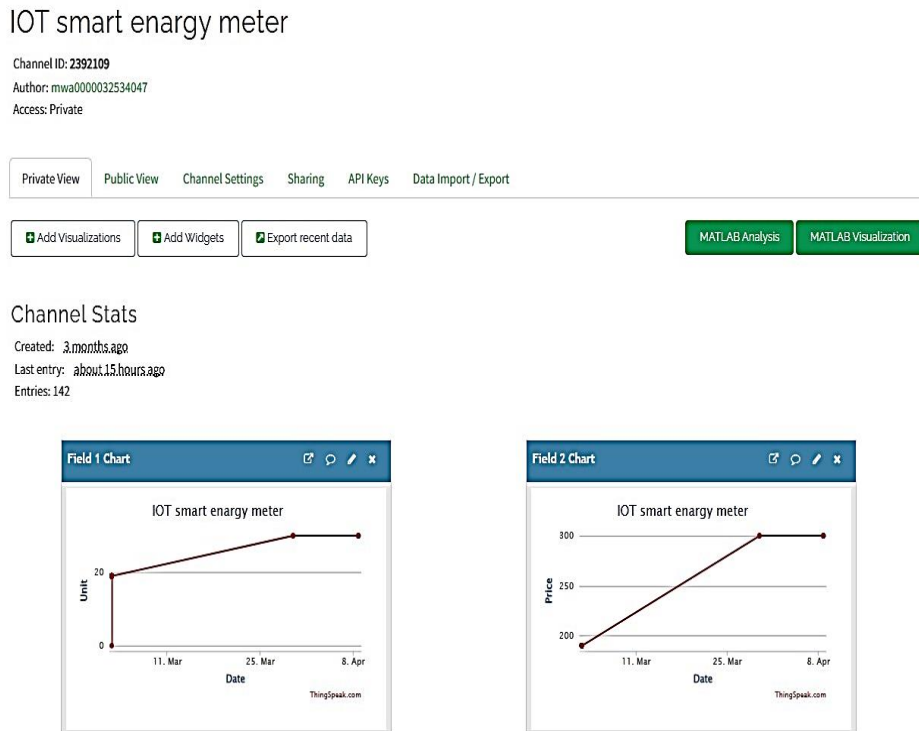

Figure 8: Data received using Node MCU on Web server

In Fig 8, the data of energy meter is received on Web server using Node MCU in the model. The data is displayed as a series of graph which is easy for the user to interpret.

**E. Performance Analysis**

Here we have performed an experiment to test our proposed model under different load variation. We have taken 4 loads of different Wattage from 100W to 400W and unit vs time graph is plotted for 10 units of consumption. These graphs are shown on webserver which will help the users to easily interpret the data and monitor and control their energy consumption.

**i) When 100W is connected to the Supply**

In Fig 9, the unit vs time graph shows 10 units of energy consumed by 100 W filament bulb. Here the graph is almost like a straight line from 50 units to 40 units and 22 minutes was taken.

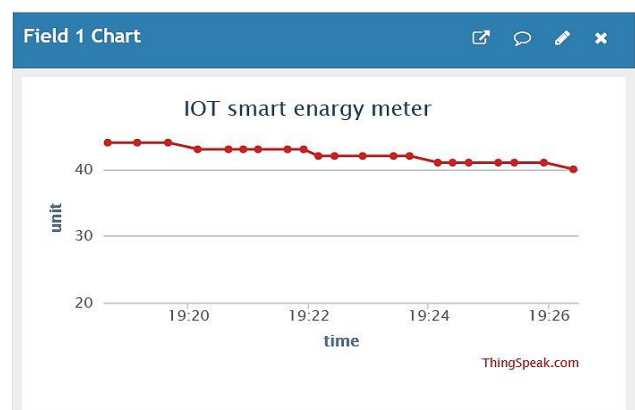

Figure 9: Unit Vs Time for 100W

**ii) When 200W is connected to the Supply**

In Fig 10, the unit vs time graph shows 10 units of energy consumed by 200 W filament bulb. Here the energy is consumed from 40 units to 30 units and graph has a little bit of inclination from the previous graph. Here it took 10 minutes less than the 100W bulb for same amount of consumption.

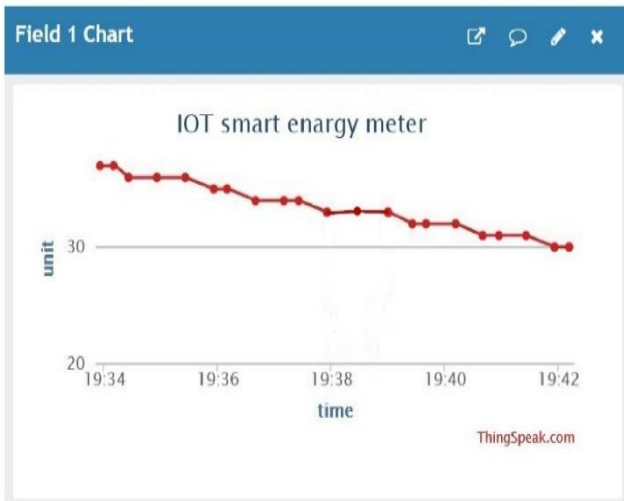

Figure 10: Unit Vs Time for 200W

**iii) When 300W is Connected to the Supply**

In Fig 11, the unit vs time graph shows 10 units of energy consumed by 300 W filament bulb. Here the units are consumed from 24 units to 14 units. The graph has more inclination from the previous graphs which shows that less time is taken than 100W (almost 13 mins).

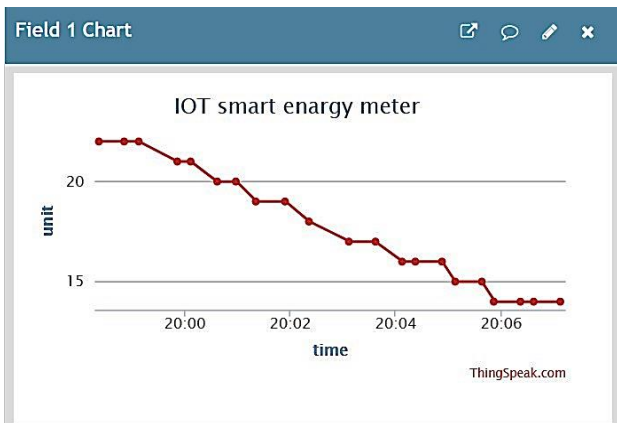

Figure 11: Unit Vs Time for 300W

**iv) When 400W is connected to the Supply**

In Fig 12, the unit vs time graph shows 10 units of energy consumed by 400 W filament bulb. Here the units are consumed from 14 units to 4 units which took 14 minutes less than 100W bulb.

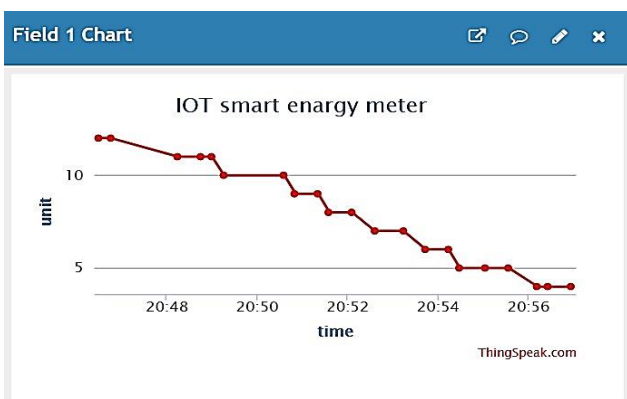

Figure 12: Unit Vs Time for 400W

**v) Time Taken by Each Load For 10 Units of Consumption**

Table 1: Time taken for 10 units of consumption

Load	Time (in min)
100 W	22:19
200 W	12:49
300 W	10:05
400 W	6:18

In the above table 1, we have collected the data about the time taken by each load to consume 10 units of energy from the graphs. This shows us that with increase in load, there is decrease in the time taken. Here the maximum deviation of time taken is observed from 100W to 200W i.e. 10 minutes.

**vi) Variation in Pulse Rate in Each Load**

Table 2: Pulse rate variation

Load	Time taken for 0-9 pulses (in min)	Time for each pulse in (in secs)
100 W	01:53	11.3
200 W	01:18	7.8
300 W	00:57	5.7
400 W	00:44	4.4

In the above table 2, we have calculated the pulse rate variation for each load. Table shows that with increase in load, pulse rate decreases. Here maximum deviation for change in each pulse is also from 100W to 200W i.e. about 5 seconds.

**V. CONCLUSION**

An attempt has been made to design a practical model of Advanced Energy Meter using IoT. The data from the meter is received via SMS and also displayed through graphs for easy interpretation and controlling. The model is also subjected to different load variation wherein we can conclude that with the increase in load wattage the units get consumed at a faster rate. This will help both the consumer and provider to monitor their power consumption on daily basis and regulate it.

**VI. FUTURE SCOPE**

In the coming Era of technology, Smart Energy Meter will see drastic advancements due to its integration with IoT. Big Data analytics will also be used to analyze the data of Smart meters. This technology will also help in enhancing the grid performance by providing insights into network health and load distribution.

Smart meters are essential for building a resilient and flexible energy system, benefitting consumers, energy providers and country's economy.



## CONFLICTS OF INTEREST

The authors declare that they have no conflicts of interest.

## REFERENCES

- [1] H. K. Patel, T. Mody, and A. Goyal, "Arduino based smart energy meter using gsm," in 2019 4th International Conference on Internet of Things: Smart Innovation and Usages (IoT-SIU). IEEE, 2019, pp. 1–6.
- [2] Himshekhar Das, L.C. saikia, "GSM Enabled Smart Energy Meter and Automation of Home Appliances" 978-1-4678-6503-1/15/\$31.00 © 2015 IEEE
- [3] Tae-Seop, Choi,Kyung-Rok, Ko,Seong-Chan, Park and Young-Sik Jang,"Analysis of energy savings using smart metering system and IHD (in home display)," Asia Pacific 2009 IEEE Transmission & Distribution Conference &Exposition, pp. 1-4, 26-30 Oct 2009.
- [4] M. Aboelmaged, Y. Abdelghani, and M. A. A. El Ghany, "Wireless IoT based metering system for energy efficient smart cites," Proc. Int. Conf. Microelectron. ICM, vol. 2017-Decem, no. Icm, pp. 1–4, 2018.
- [5] D. S. A. Joshi, S. Kolvekar, Y. R. Raj, and S. S. Singh, "IoT Based Smart Energy Meter," Bonfring Int. J. Res.Comm. Eng., vol. 6, no. Special Issue, pp. 89–91,2016.
- [6] S. Visalatchi and K. Kamal Sandeep, "Smart energy metering and power theft control using arduino & GSM," 2017 2nd Int. Conf. Converg. Technol. I2CT 2017, vol. 2017-Janua, pp. 858–861, 2017.
- [7] S. Priya, A. Srivastava, S. K. Jindal, and S. K. Sahoo, "Design and Implementation of a Smart Energy Meter Based on Internet of Things and Neural Network Approach," Ssrn, pp. 650–657, 2018.
- [8] V.Kurde, Arati;Kulkarni, "IOT Based Smart Power Metering," Int. J. Sci. Res. Publ., vol. 6, no. 9, pp. 411–415, 2016.
- [9] K. Pal, A. Ranjan, A. Mishra, C. P. Singh, and A.Srivastava, "Electric meter reading through IOT by using Raspberry pi model," pp. 3603–3608, 2018.
- [10] G. H. L. I. of T. and S. V.Preethi(Vignan's Lara Institute of Technology and Science), "DESIGN AND IMPLEMENTATION OF SMART ENERGY METER," Bull. Phys. Fit. Res. Inst., no. 96, pp. 1–14, 2016.
- [11] J. A. Mathews, J. Varghese, J. Raju, and L. Daley, "Intelligent Energy Meter with Power Theft Detection," no. 4, pp. 112–117, 2017.
- [12] N. V. Patil, R. S. Kanase, D. R. Bondar, and P. D. Bamane, "Intelligent energy meter with advanced billing system and electricity theft detection," 2017 Int. Conf. Data Manag. Anal. Innov. ICDMAI 2017, pp. 36–41, 2017.
- [13] C. Mhatre, "Iot Based Smart Energy Monitoring," vol.3, pp. 2522–2526, 2018.
- [14] V. Bhuvanewari and R. Porkodi, "The internet of things (IOT) applications and communication enabling technology standards: An overview," Proc. -2014 Int. Conf. Intell. Comput. Appl. ICICA 2014, pp.324–329, 2014.
- [15] C. Landi, P. Merola, and G. Ianniello, "Arm-based energy management system using smart meter and web server," in 2011 IEEE International Instrumentation and Measurement Technology Conference. IEEE, 2011, pp. 1–5.